

INFORMATION ONLY

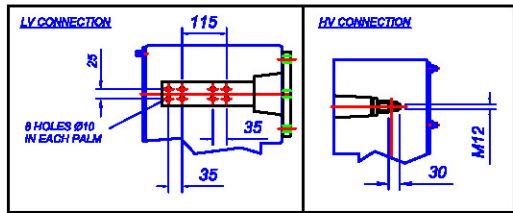

NOT APPROVED

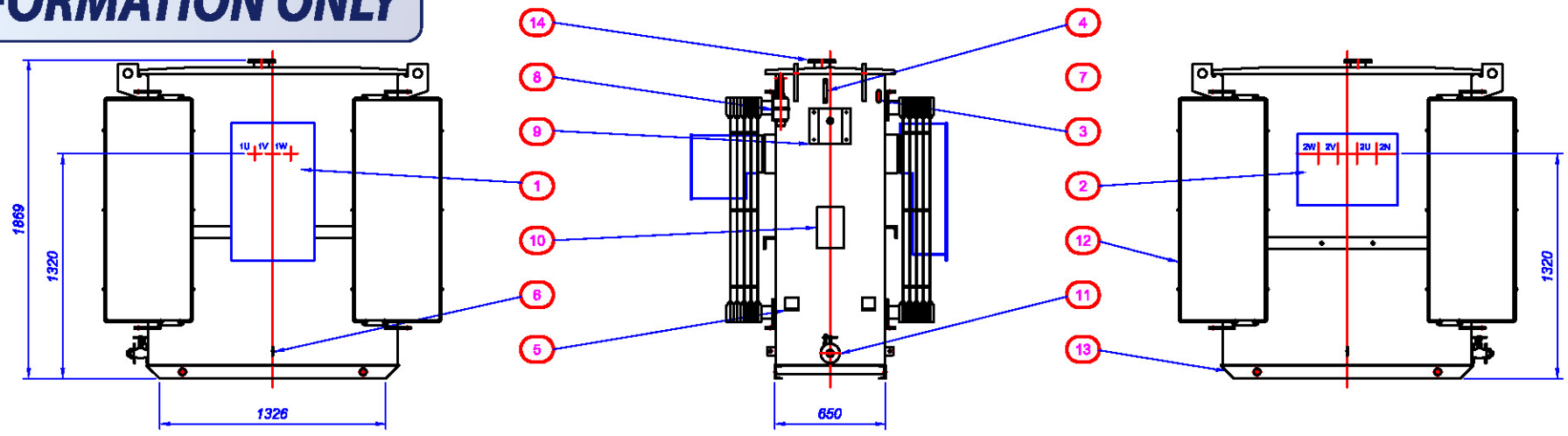
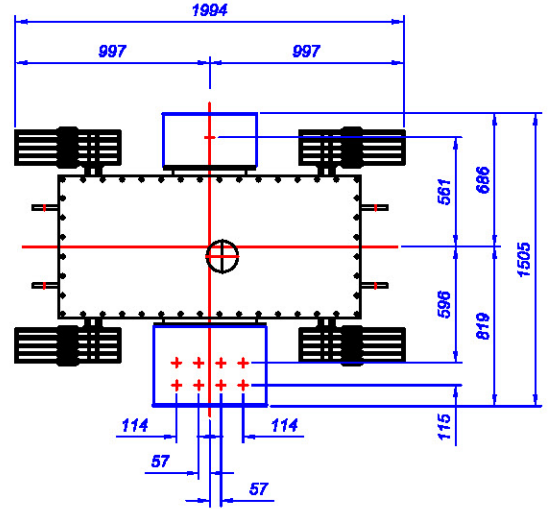

ITEM	DESCRIPTION
1	HV CABLE BOX 3 POLE 1 GLAND (TERMINATION KIT REQD)
2	LV CABLE BOX 4 POLE 8 GLAND AIR FILLED
3	THERMOMETER POCKET
4	LIQUID LEVEL GAUGE
5	JACKING ANGLES
6	EARTH TERMINAL (ONE EACH SIDE)
7	MAIN LIFTERS
8	SILICA GEL BREATHER (SUPPLIED LOOSE)
9	TAPPING SELECTOR CONTROL HANDLE (ENCLOSED IN COVER)
10	RATING AND DIAGRAM PLATE
11	1" BSP DRAIN VALVE AND PLUG
12	INTEGRAL TYPE RADIATOR, 1200 CENTRES, 5 PANELS
13	BASE SKIDS DRILLED FOR ROLLER AXLES
14	LIQUID FILLER PLATE

BOWERS JOB No.	-
OUTPUT	1250 kVA
VOLTAGE RATIO	11000 / 415
AMPERES	85.61 / 1739
PHASES	3
FREQUENCY	50Hz
VECTOR SYMBOL	Dyn11

ESTIMATED WEIGHTS		KG
CORE AND WINDINGS		2100
COOLING LIQUID	988 LTRS	820
TOTAL WEIGHT		3740



This drawing is COPYRIGHT and the property of Bowers Electricals Ltd. It must not be copied (in whole or in part) without prior written consent of the company.

TOLERANCE UNLESS OTHERWISE STATED:
 ± 5mm FOR DIMENSIONS UP TO 250mm;
 ± 10mm FOR DIMENSIONS UP TO 1000mm;
 ± 20mm FOR DIMENSIONS OVER 1000mm.

RevNo	Revision Note	Date	Signed	Checked

Bowers
 Electricals Ltd
 Heaton Gate Road,
 Heaton, Derbyshire, DE75 7GX
 Tel: 01773 631631 Fax: 01773 716171
 E-mail: enquiries@bowerselec.co.uk

Drawn by M.NEWTON
 Checked by T.BARKS
 Approved by A.V.HALL
 Job No. STOCK
 Date 02/12/16
 Size A2

GENERAL ARRANGEMENT OF 1250KVA 11000/415v ONAN Dyn11 ALUMINIUM WOUND ECO TRANSFORMER
DRG No. BE7475
 FIRST ANGLE
 Scale 1:20
 Revision 0
 Sheet 1/1